

# MPT SERIES

## RETURN FILTER



**MPFILTER**  
filtri per oleodinamica



Maximum working pressure 7 bar

Flow rates to 150 l/min

# D e s c r i p t i o n

# MPT

MPT series filters are designed for return lines, and are installed semi-immersed in a reservoir.

The MPT series are available with an air breather designed into the head of the filter assembly.

Continued Research and Development on both the filter bodies and the filter elements has resulted in a product line with excellent pressure drop characteristics combined with a high filtration efficiency.

The high flow rate bypass valves is a standard feature with this range of product.

MPT filters within this range are suitable for flow rates up to 150 l/min.

MPT series are specifically designed for use on small power packs for industrial, mobile and lift truck applications.

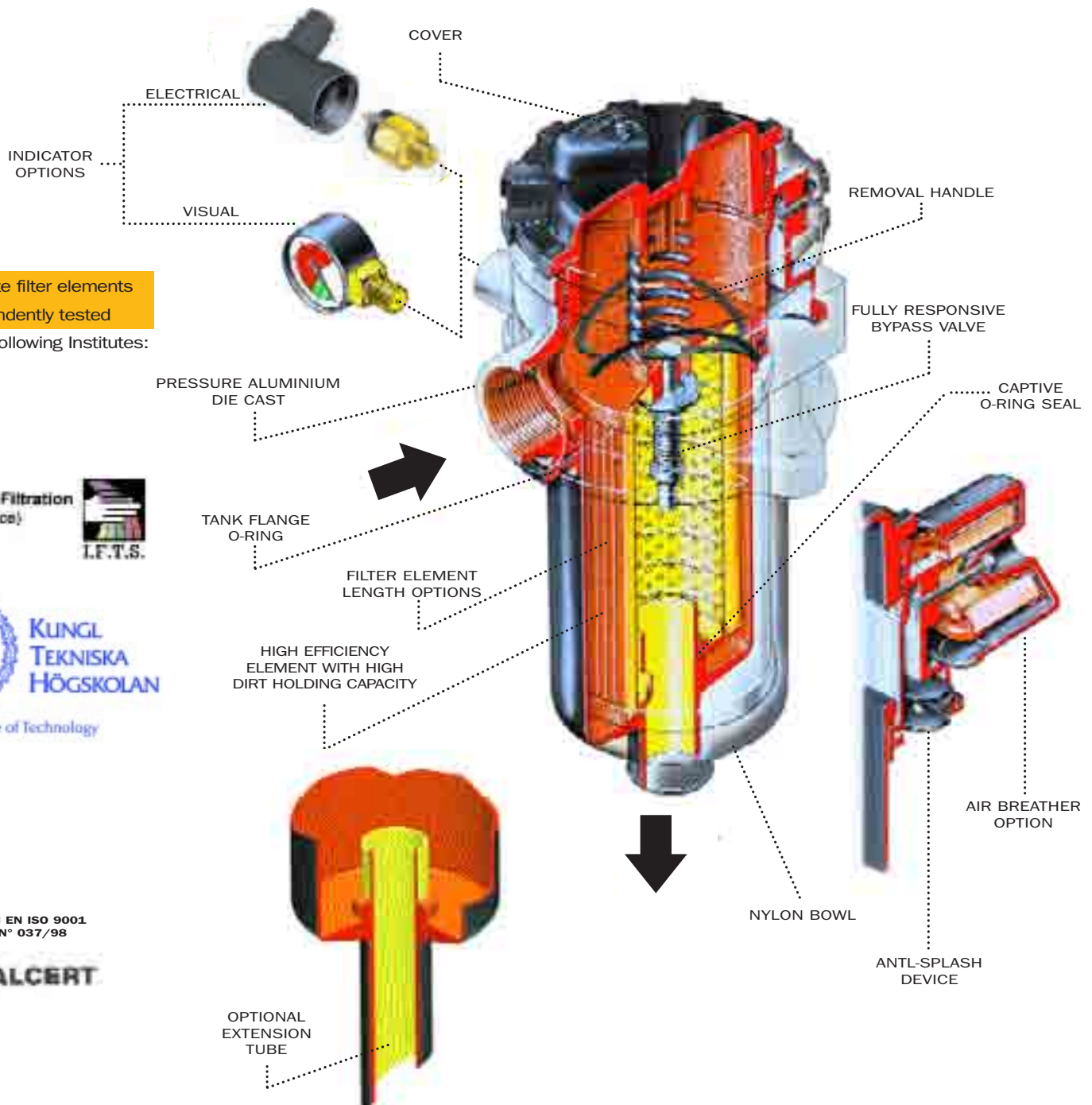

## New

absolute filter elements  
independently tested  
in the following Institutes:

Institute of Filtration  
(France)



KUNGL. TEKNISKA  
HÖGSKOLAN

Royal Institute of Technology



## Filter element:

### Materials

### End caps:

Nylon

### Support tube:

Galvanized steel

### Support frames:

Coated wire mesh

### A Series

Inorganic microfibre

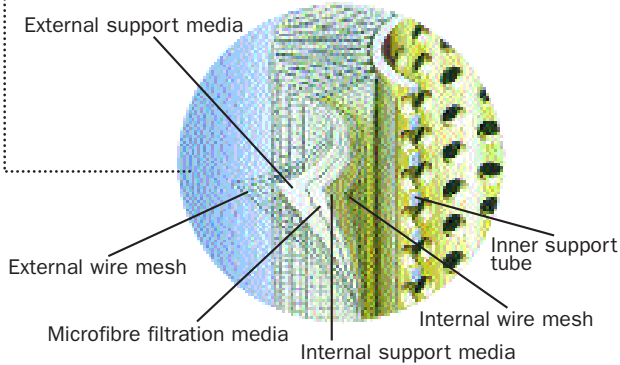

### MP Filter elements - Conform to the following ISO standards

- ISO 2941 - Verification of collapse/burst resistance.
- ISO 2942 - Verification of fabrication integrity and determination of the first bubble point.
- ISO 2943 - Verification of material compatibility with fluids.
- ISO 3723 - Method for end load test.
- ISO 3724 - Verification of flow fatigue characteristics.
- ISO 3968 - Evaluation of pressure drop versus flow characteristics.
- ISO 4572 - Multi-pass method for evaluating filtration performance.

### Element material Absolute filtration

## A Series

Inorganic microfibre with acrylic support

### Contamination retention

as per ISO 4572: Multi-pass test.

**New improved  $\beta \geq 200$  filter elements with greater efficiency and increased dirt holding capacity**

Filter elements	Dimensions for $\beta$ ( $\mu\text{m}$ ) values				Filtration ratios			$\Delta P$ (bar)
	$\beta \geq 2$ (50%)	$\beta \geq 20$ (95%)	$\beta \geq 75$ (98,7%)	$\beta \geq 200$ (99,5%)	$\beta_2$	$\beta_{10}$	$\beta_{20}$	
A03	-	2	2,4	3	20	> 10.000	> 10.000	7
A06	-	3	4,6	6	8	> 2.000	> 10.000	7
A10	3	6	7,8	10	1,5	$\geq 200$	> 10.000	7
A25	13	19	22	25	-	> 1,5	> 35	7

N.B. Other materials giving different degrees of filtration are available on request.

### Filtering area Filter elements H - $\Delta P$ 10 bar

Type MF	020-1	020-2	020-3	100-1	100-2	100-3
A03/A06	420	790	1000	630	1000	1730
A10/A25	420	790	1000	630	1000	1730

Values in  $\text{cm}^2$

### Element material Nominal filtration

## P Series

Resin - impregnated paper

## M Series

Square wire mesh (filtration degree is defined in microns by the maximum diameter of a sphere corresponding to the mesh size)

### Filtering area Filter elements N - $\Delta P$ 3 bar

Type MF	020-1	020-2	020-3	100-1	100-2	100-3
P10/P25	500	880	1100	1020	1660	1900
M25	410	720	900	460	730	1250
M60	410	720	900	460	730	1250
M90	410	720	900	460	730	1250

Values in  $\text{cm}^2$

## Filter body:

### Materials

#### Head

Pressure die cast aluminium

#### Cover

Nylon

#### Bowl

Nylon

#### Seals

A Series: Nitrile (Buna-N)

V Series: Viton

#### Bypass valve

Nylon

#### Indicator

Brass

### Working temperature

From -25 to +110°C

For temperatures outside this range, please consult our Sales Network Organization

### Pressure filter body

Maximum working pressure up to 7 bar

Test pressure: 10 bar

Minimum burst pressure: 20 bar

Fatigue test: a filter body subjected to pressure impulses from 0 to 7 bar will withstand 1.000.000 cycles

### Collapse pressure filter elements

N Series

**3 bar**

H Series

**10 bar**

### Bypass valve

#### Calibration pressure

Bypass valve, differential opening pressure:

**B: 1.75 bar ± 10%**

### Compatibility with fluids

#### Filter head and bowls

compatible for use with:

- mineral oils (types HH-HL-HM-HR-HV-HG as per ISO 6743/4)
- water-based emulsions (types HFAE-HFAS as per ISO 6743/4)
- synthetic fluids (types HS-HFDR-HFDS-HFDU as per ISO 6743/4)
- water-glycol (types HFC as per ISO 6743/4)

**Ask for anodized version**

#### Filter elements

As per ISO 2943; suitable for mineral oils (types HH-HL-HM-HR-HV-HG as per ISO 6743/4) synthetic fluids (A and M series only) (types HS-HFDR-HFDS-HFDU as per ISO 6743/4)

For water-based emulsions (types HFAE-HFAS as per ISO 6743/4) and fluids other than those mentioned, please consult our Sales Network Organization.

#### Seals

##### A Series

**Nitrile (Buna-N)** compatible with mineral oils (types HH-HL-HM-HR-HV-HG as per ISO 6743/4) water-based emulsions (types HFAE-HFAS as per ISO 6743/4)

water-glycol (types HFC as per ISO 6743/4)

##### V Series

**Viton** compatible with synthetic fluids (types HS-HFDR-HFDS-HFDU as per ISO 6743/4)

### Types of indicators

Description:

**MPT** series filters are fitted with indicators switching at a pressure of

1.3 bar ± 10%

#### Visual indicator

**VR Series** bottom connection **MPT 100**  
**V1 Series** rear connection **MPT 020**

Colour coded pressure gauge scale 0÷6 bar

#### Electrical indicator

##### ER Series:

Pressure switch with N.O. contacts

##### EC Series:

Pressure switch with N.C. contacts

#### Operational information:

Max voltage: 48 Vac 50÷60 Hz

Max current: 0.5 A resistive, 0.2 A inductive.

# Selection & installation information

## Filter elements types

### A Series

Absolute inorganic microfibre filtration media, available in 3, 6, 10 and 25 micron  
Example - **A03, A06, A10** or **A25**

### P Series

Nominal cellulose impregnated paper media, available in 10 and 25 micron.  
Example - **P10** or **P25**

### M Series

Metal mesh media, available in 25, 60, and 90 micron.  
Example - **M25, M60** or **M90**.

**Please refer to individual pressure drop curves to obtain filter assembly pressure drop information**

The following filter sizing recommendations are based using a mineral oil fluid at 30 mm<sup>2</sup>/s (cSt) with a maximum total filter assembly (housing and filter element) pressure drop of 30% of the filter condition indicator (0.4 bar)

## MPT 020

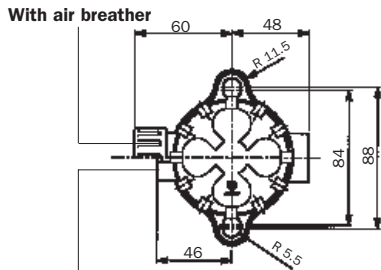
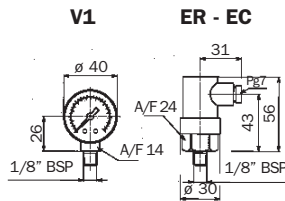
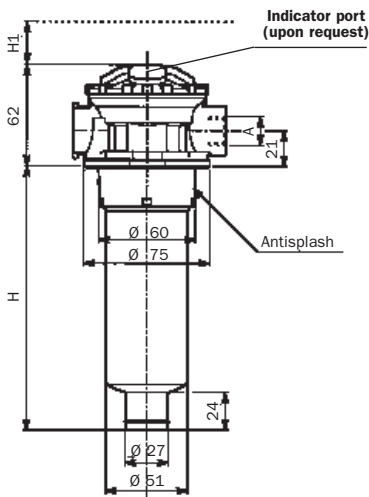

### Holes on the tank

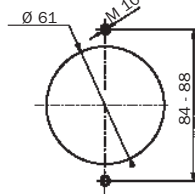

Without air breather

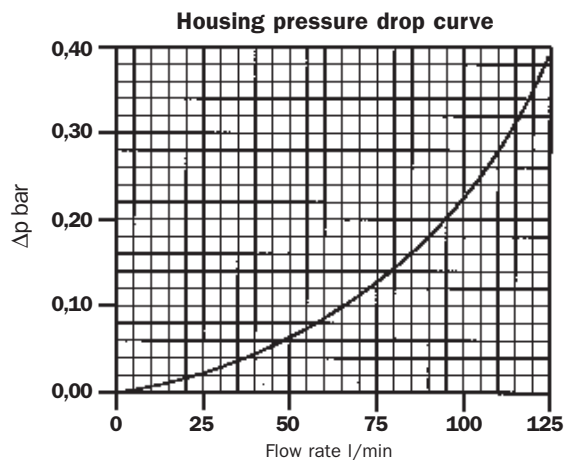

## MPT SERIES 020 SIZE

Filter assembly	Flow rate l/min *	Bowl length	Port size BSP/NPT/SAE	Weight kg **
A03	17	1	3/8"	0,3
A06	19			
A10	26			
A25	30			
P10	45	2	3/8"	0,4
A03	19			
A06	22			
A10	30			
A25	40	3	1/2"	0,5
P10	65			
A03	34			
A06	38			
A10	50	3	1/2"	0,5
A25	85			
P10	90			

\* Flow rates with 30 mm<sup>2</sup>/s fluid viscosity  
\*\* Weight including filter element

## Lengths

Type	H	H1
1	102	115
2	165	180
3	210	210

## Thread connections

Type	A
G1	3/8" BSP
G2	1/2" BSP
G3	Not available
G4	3/8" NPT
G5	1/2" NPT
G6	Not available
G7	SAE 6 - 9/16" - 18 UNF
G8	SAE 8 - 3/4" - 16 UN
G9	Not available



# Selection & installation information

Please refer to individual pressure drop curves to obtain filter assembly pressure drop information

The following filter sizing recommendations are based using a mineral oil fluid at 30 mm<sup>2</sup>/s (cSt) with a maximum total filter assembly (housing and filter element) pressure drop of 30% of the filter condition indicator (0.4 bar)

## MPT 100

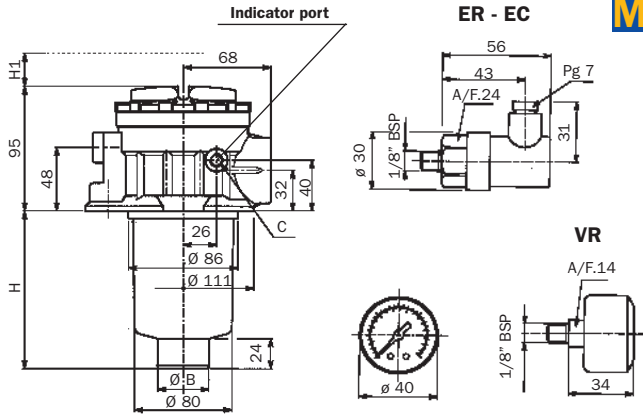

With air breather

Holes on the tank

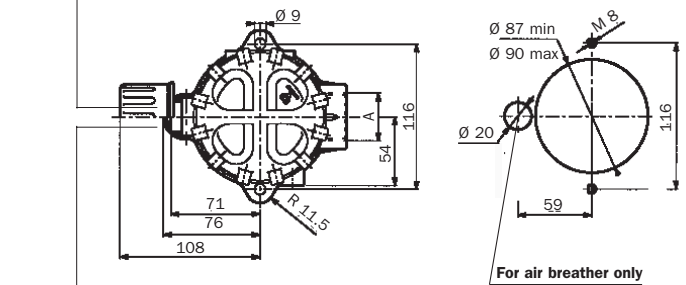

Without air breather

## MPT SERIES 100 SIZE

Filter assembly	Flow rate l/min *	Bowl length	Port size BSP/NPT/SAE	Weight kg **
A03	27	1	3/4"	1
A06	30			
A10	32			
A25	70			
P10	50	2	3/4"	1,2
A03	35			
A06	43			
A10	50			
A25	130	3	1"	1,3
P10	95			
A03	48			
A06	58			
A10	75	1 1/4"	1 1/4"	1,3
A25	200			
P10	130			

\* Flow rates with 30 mm<sup>2</sup>/s fluid viscosity  
\*\* Weight including filter element

### Lengths

Type	H	H1	Ø B
1	102	100	29
2	145	145	29
3	225	230	43

### Thread connections

Type	A	C
G1	3/4" BSP	1/8" BSP
G2	1" BSP	1/8" BSP
G3	1 1/4" BSP	1/8" BSP
G4	3/4" NPT	1/8" NPT
G5	1" NPT	1/8" NPT
G6	1 1/4" NPT	1/8" NPT
G7	SAE 12 - 1 1/16" - 12 UN	1/8" NPT
G8	SAE 16 - 1 5/16" - 12 UN	1/8" NPT
G9	SAE 20 - 1 5/8" - 12 UN	1/8" NPT

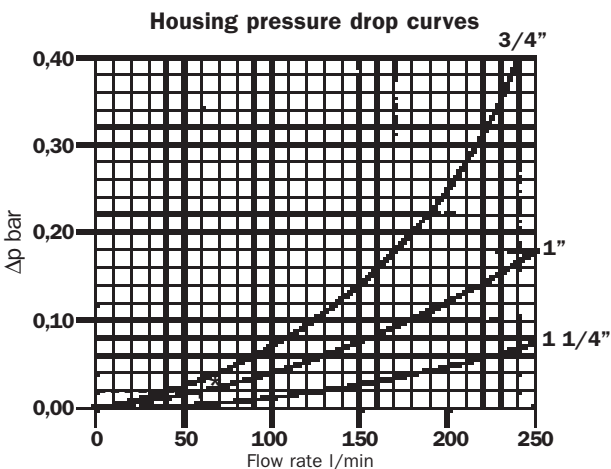

## General

Pressure drop versus flow rate curve information for both housing and filter elements is in accordance with ISO 3968

**Filter assembly pressure drop** -  $\Delta p_{\text{Total}} = \Delta p_{\text{Housing}} + \Delta p_{\text{Filter element}}$

**Housing pressure drop** - The housing pressure drop is proportional to the fluid density

**Filter element pressure drop** - Filter element pressure drop is proportional to kinematic viscosity therefore always check the fluid operating temperature and fluid type to obtain the working viscosity according to the following formula:

$$\Delta p_1 \text{ Filter element} = (\text{working viscosity} / \text{brochure viscosity}) \times \Delta p \text{ filter element}$$

Brochure viscosity 30 mm<sup>2</sup>/s (cSt)

## Filter assembly sizing example

- Customer requires a 60 l/min filter assembly
- Mineral oil fluid: ISO VG 68 (68 mm<sup>2</sup>/s (cSt) at 40°C)
- A25 - 25 micron absolute filtration

### Selection :

- **Housing pressure drop** - MPT 100 (1" BSP or NPT option) with 60 l/min  $\Delta p = 0.02$  bar (see curve on page 6)
- **Filter element pressure drop** (brochure viscosity) - MF 100.2.A25HB with 60 l/min  $\Delta p = 0.15$  bar (see curve on page 8)
- **Filter element pressure drop** (working viscosity) - With 68 mm<sup>2</sup>/s (cSt)  $\Delta p_1 = 0.15 \times (68/30) = 0.34$  bar
- **Filter assembly pressure drop**  $\Delta p_{\text{Total}} = \Delta p_{\text{Housing}} + \Delta p_1 \text{ Filter element} = 0.02 + 0.34 = \mathbf{0.36 \text{ bar}^*}$  { Acceptable pressure drop value, as per our recommendations

## Bypass valves pressure drop

The curves were obtained using a mineral oil with a density of 0,86 kg/dm<sup>3</sup>.  
The  $\Delta p$  varies proportionally to the density.

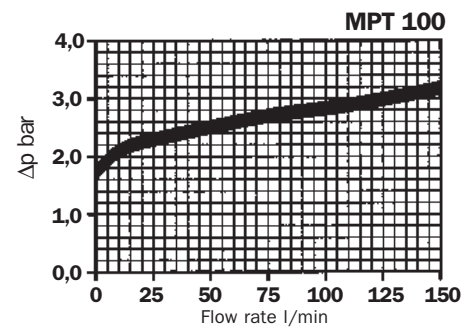
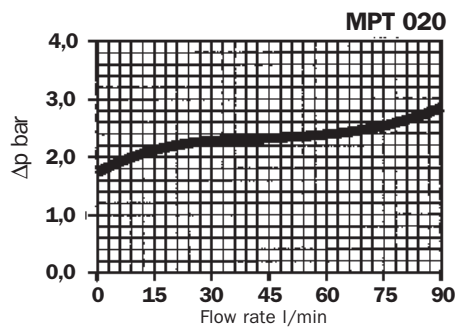

## Filter elements - N - $\Delta P$ 3bar

The curves were obtained using a mineral oil with a kinematic viscosity of  $30 \text{ mm}^2/\text{s}$  (cSt).  
The  $\Delta p$  varies proportionally to the fluid kinematic viscosity.

For the metal mesh filter elements curves (M series), please consult our Sales Network Organization

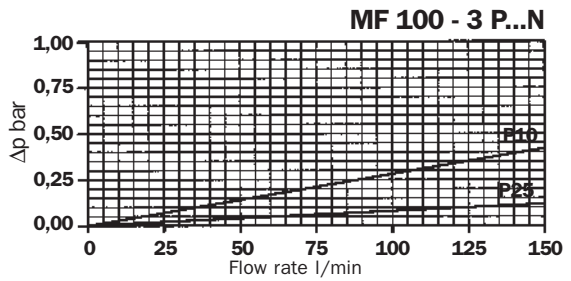
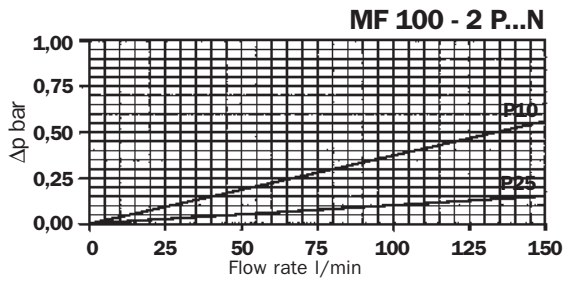
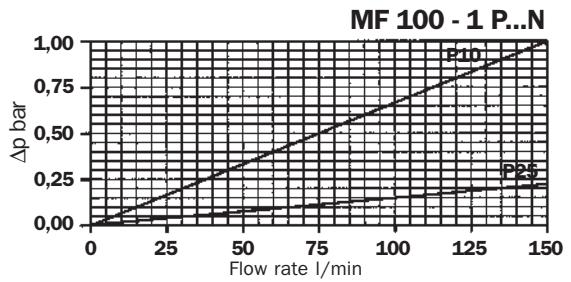
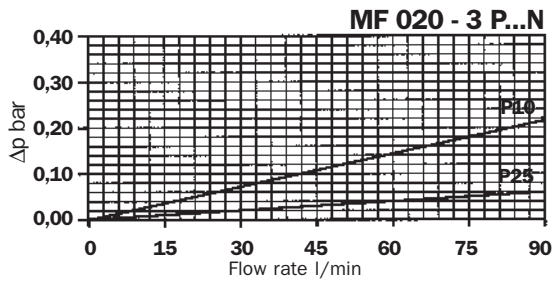
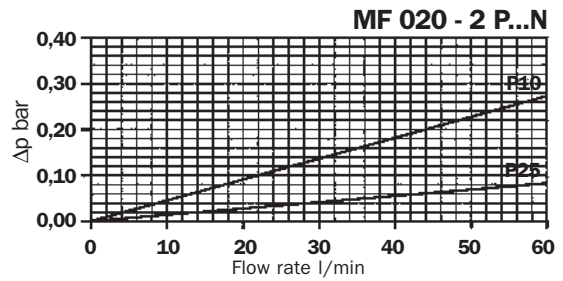
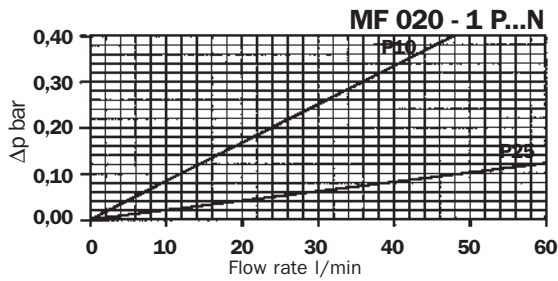

## Filter elements - H - $\Delta P$ 10bar

The curves were obtained using a mineral oil with a kinematic viscosity of  $30 \text{ mm}^2/\text{s}$  (cSt).  
The  $\Delta p$  varies proportionally to the fluid kinematic viscosity.

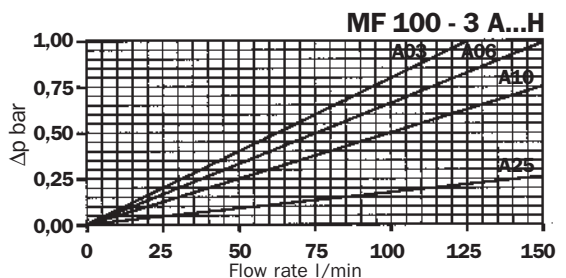
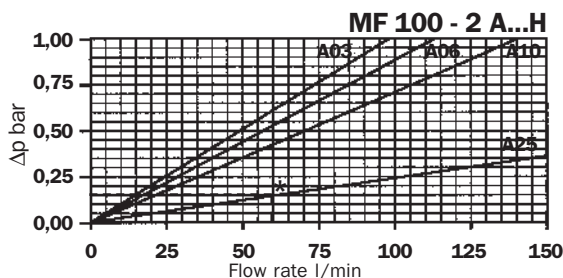
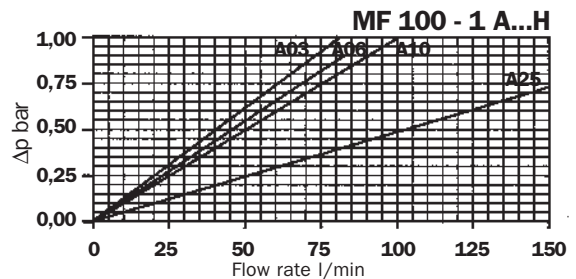
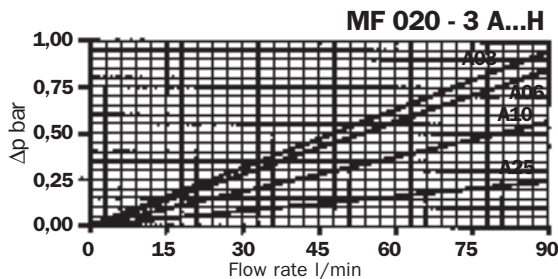
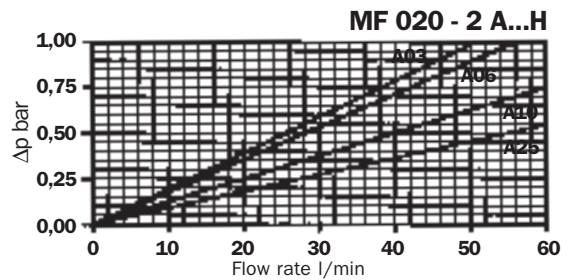
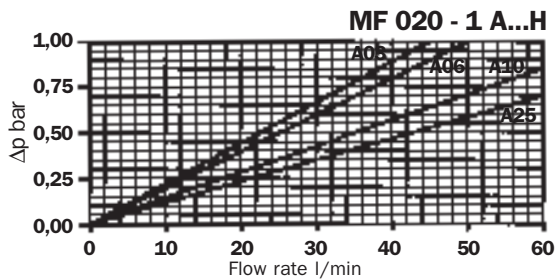



## Filter element replacement

The filter element has a handle on the top allowing easy removal of itself from the bowl.

The helical spring is utilized to secure the filter element in its location.

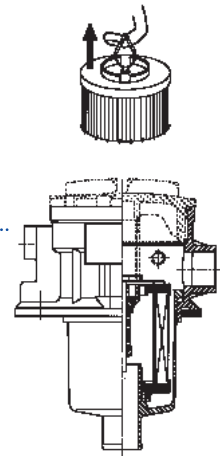

## Special applicazion filters on request

### Extension tube:

Ordering code and length

CODE XX	LENGTH "H" in mm.
10	100
11	110
12	120
...	...
99	990

#### NOTES:

- When extension tube is ordered, indicator must be ordered separately.
- Extension tube lengths have variable sizes multiple of 10 mm.

**Example:** Length H = 300 mm. Visual indicator.

**Filter code:** MPT 100 1C - AG1 A10HB/30 - **Indicator code:** VR

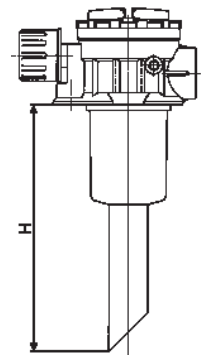

## Applications

### Example of application

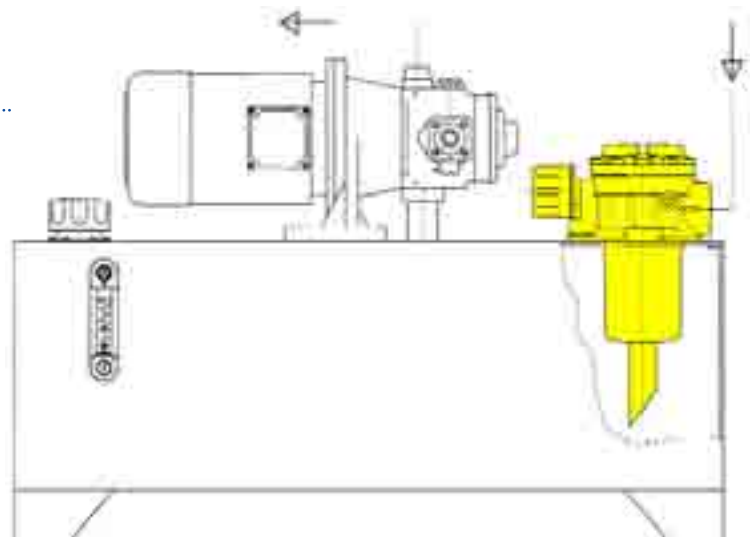



## MPT

### Nominal sizes

020  
100

### Bowl lengths

MPT 020 = 1,2,3  
MPT 100 = 1,2,3

### Air breather

S	Without air breather
C	With 10 µm air breather
M	With 40 µm air breather

### Seals

A	Nitrile (Buna-N)
V	Viton

### Ports option

Type	MPT 020	MPT 100
G1	3/8" BSP	3/4" BSP
G2	1/2" BSP	1" BSP
G3	-	1 1/4" BSP
G4	3/8" NPT	3/4" NPT
G5	1/2" NPT	1" NPT
G6	-	1 1/4" NPT
G7	SAE 6	SAE 12
G8	SAE 8	SAE 16
G9	-	SAE 20

### Filter condition indicator

Standard option for MPT 100,  
Customer request for MPT 020

S	With threaded hole only
T	With plug
V1	Visual (upon request MPT 020)
VR	Visual
ER	Electrical: N.O. contacts
EC	Electrical: N.C. contacts
XX	Extension tube (see page 9)

### Bypass valve

B	Bypass 1.75 bar
---	-----------------

### Seals (Filter elements)

B	Nitrile (Buna - N)
V	Viton

### Collapse pressure series

N	3 bar (P/M series)
H	10 bar (A series, only)

### Filter elements N series

P10 P25	Resin-impregnated paper Bx ≥ 2
M25 M60 M90	Square wire mesh

### Filter elements H series

A03 A06 A10 A25	Inorganic microfibre Bx ≥ 200
--------------------------	-------------------------------

## MF

# Replacement element

MP Filtri - Filtration products will only be guaranteed if original MP Filtri replacement elements and spares are used

Data held in this publication is given only for indicative purposes. MP Filtri reserves to introduce modifications to described items for technical or commercial reasons. Copyright reserved.



**Head Quarter :**

**MP FILTRI S.p.A. Italy**

Via Matteotti, 2  
20060 Pessano con Bornago (Milano) Italy  
Tel. ++39.02/95703.1  
Fax ++39.02/95741497-95740188  
email: sales@mpfiltri.com  
<http://www.mpfiltri.com>



**GREAT BRITAIN**

**MP FILTRI U.K. Ltd.**

Bourton Industrial Park  
Bourton on the Water  
Gloucestershire GL54 2HQ UK  
Phone: 01451-822522  
Fax: 01451-822282  
email: sales@mpfiltri.co.uk  
<http://www.mpfiltri.co.uk>

**GERMANY**

**MP FILTRI D GmbH**

Am Wasserturm 5  
D-66265 Heusweiler/Holz  
Phone: 06806/85022-0  
Fax: 06806/85022-18  
email: mpfiltrink@aol.com

**FRANCE**

**MP FILTRI FRANCE**

B.P. 325  
01603 Trevoux Cedex  
Tel: 04.74.08.84.78  
Telefax: 04.74.08.80.45  
email: mpfiltrifrance@wanadoo.fr

**USA**

**MP FILTRI USA Inc.**

2055 Quaker Pointe Drive  
Quakertown, PA 18951  
Phone: 215-529-1300  
Fax: 215-529-1902  
email: mpusasales@aol.com  
<http://www.mpfiltriusa.com>

**CANADA**

**MP FILTRI CANADA Inc.**

210 Jacob Keffer Parkway Concord,  
Ontario Canada L4K 4W3  
Phone: 905-303-1369  
Fax: 905-303-7256  
email: mail@mpfiltricanada.com  
<http://www.mpfiltricanada.com>