

MPH SERIES

RETURN FILTER



MPFILTRI
Filtrazione per idrodinamica



Maximum working pressure 10 bar

Flow rates to 2000 l/min

Description

MPH

MPH and **MPI** series filters are designed for return-line applications and provide various installation applications. The filters are installed semi-immersed (**MPH**) or totally immersed into a reservoir (**MPI**). The filtration flow is from inside to outside of the filter element which ensures that all the contaminant is collected inside the element itself avoiding contact with the reservoir oil during element change. The combination of magnetic pre-filtration and high filtration efficiency results in a cost effective and versatile filtration series.

The high flow rapid response bypass valves are a standard feature with this range of filters.

The **MPH 100** series are available with an option of an air breather.

The **MPH-MPI 250, 630, 850** series can be specified with dual inlet ports.

MPH-MPI filters within this range are suitable for flow rates up to 2000 l/min.

MPH-MPI series are specifically designed for heavy duty mobile machinery and process plant applications.

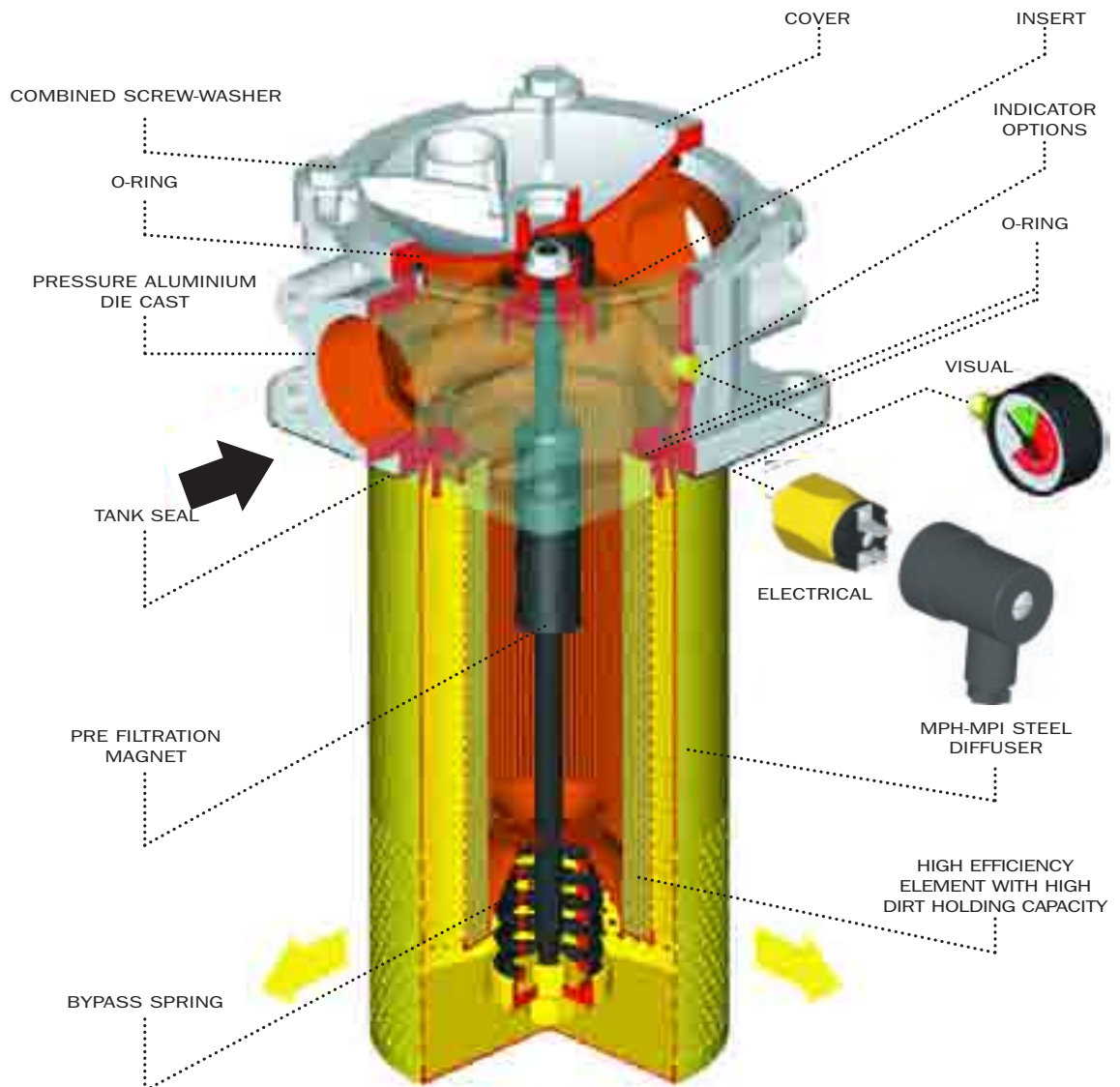

New

absolute filter elements
independently tested
in the following Institutes:

Institute of Filtration
(France)



Royal Institute of Technology



Filter element:

Materials

End caps:

Nylon

Support tube:

Galvanized steel

Support frames:

Coated wire mesh

A Series

Inorganic microfibre

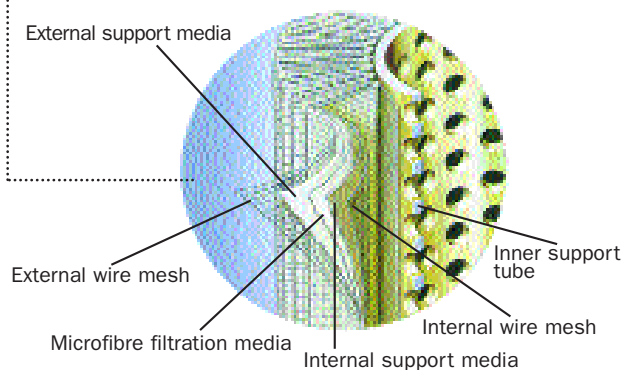

MP Filter elements - Conform to the following ISO standards

- ISO 2941 - Verification of collapse/burst resistance.
- ISO 2942 - Verification of fabrication integrity and determination of the first bubble point.
- ISO 2943 - Verification of material compatibility with fluids.
- ISO 3723 - Method for end load test.
- ISO 3724 - Verification of flow fatigue characteristics.
- ISO 3968 - Evaluation of pressure drop versus flow characteristics.
- ISO 4572 - Multi-pass method for evaluating filtration performance.

Element material Absolute filtration

New improved $\beta \geq 200$ filter elements with greater efficiency and increased dirt holding capacity

A Series

Inorganic microfibre with acrylic support

Contamination retention

as per ISO 4572: Multi-pass test.

Filter elements	Dimensions for $\beta(\mu\text{m})$ values				Filtration ratios			ΔP (bar)
	$\beta \geq 2$ (50%)	$\beta \geq 20$ (95%)	$\beta \geq 75$ (98,7%)	$\beta \geq 200$ (99,5%)	β_2	β_{10}	β_{20}	
A06	-	3	4,6	6	8	> 2.000	>10.000	7
A10	3	6	7,8	10	1,5	≥ 200	>10.000	7
A25	13	19	22	25	-	> 1,5	> 35	7

N.B. Other materials giving different degrees of filtration are available on request.

Type MR	100-1	100-2	100-3	100-4	250-1	250-2	250-3	250-4
A06	840	1255	1710	2620	2800	3900	5450	10000
A10/A25	840	1255	1710	2620	2800	3900	5450	10000

Values in cm²

Type MR	630-1	630-2	630-3	630-4	850-1	850-2	850-3	850-4
A06	5550	7810	10650	13100	18400	30800	46500	61700
A10/A25	5550	7810	10650	13100	18400	30800	46500	61700

Values in cm²

Filtering area Filter elements

Element material Nominal filtration

P Series

Resin - impregnated paper

M Series

Square wire mesh (filtration degree is defined in microns by the maximum diameter of a sphere corresponding to the mesh size)

Filtering area Filter elements

Type MR	100-1	100-2	100-3	100-4	250-1	250-2	250-3	250-4
P10/P25	1300	1800	2640	3800	3500	4800	6600	11900
M25	620	820	1255	1830	1135	1575	2191	4000
M60	620	820	1255	1830	1135	1575	2191	4000
M90	620	820	1255	1830	1135	1575	2191	4000

Values in cm²

Type MR	630-1	630-2	630-3	630-4	850-1	850-2	850-3	850-4
P10/P25	6700	9400	12600	15500	22190	37260	56020	74520
M25	2228	3124	4244	5230	6630	11100	16300	22215
M60	2228	3124	4244	5230	6630	11100	16300	22215
M90	2228	3124	4244	5230	6630	11100	16300	22215

Values in cm²

Filter body:

Materials	Head Pressure die cast aluminium	Seals A Series: Nitrile (Buna-N) V Series: Viton	
	Cover MPH 100 Nylon MPH 250-630 Aluminium MPH 850 Steel		Bypass valve Steel
	Diffuser Steel		Indicator Brass
Working temperature	From -25 to +110°C For temperatures outside this range, please consult our Sales Network Organization		
Pressure filter body	Maximum working pressure up to 10 bar Test pressure: 15 bar Minimum burst pressure: 30 bar	Fatigue test: a filter body subjected to pressure impulses from 0 to 10 bar will withstand 1.000.000 cycles	
Collapse pressure filter elements	10 bar		
Bypass valve Calibration pressure	Bypass valve, differential opening pressure:	B: 0.8 bar ± 10% C: 1.75 bar ± 10%	
Compatibility with fluids	Filter head and bowls compatible for use with: • mineral oils (types HH-HL-HM-HR-HV-HG as per ISO 6743/4) • water-based emulsions (types HFAE-HFAS as per ISO 6743/4) • synthetic fluids (types HS-HFDR-HFDS-HFDU as per ISO 6743/4) • water-glycol (types HFC as per ISO 6743/4) Ask for anodized version	Filter elements As per ISO 2943; suitable for mineral oils (types HH-HL-HM-HR-HV-HG as per ISO 6743/4) synthetic fluids (A and M series only) (types HS-HFDR-HFDS-HFDU as per ISO 6743/4) For water-based emulsions (types HFAE-HFAS as per ISO 6743/4) and fluids other than those mentioned, please consult our Sales Network Organization.	
	Seals A Series Nitrile (Buna-N) compatible with mineral oils (types HH-HL-HM-HR-HV-HG as per ISO 6743/4) water - based emulsions (types HFAE-HFAS as per ISO 6743/4)	water - glycol (types HFC as per ISO 6743/4) V Series Viton compatible with synthetic fluids (types HS-HFDR-HFDS-HFDU as per ISO 6743/4)	
Types of indicators	Description: MPH series filters are fitted with indicators switching	at a pressure of 1.3 bar ± 10% (with bypass 1.75 bar setting) at a pressure of 0.6 bar ± 10% (with bypass 0.8 bar setting)	
Visual indicator	VT Series for filter with bypass 0.8 bar VR Series for filter with bypass 1.75 bar V1 Series for filter with bypass 1,75 bar (MPH 850, only)	Colour coded pressure gauge scale 0÷3 bar Colour coded pressure gauge scale 0÷6 bar	
Electrical indicator	With bypass 0.8 bar EQ Series: Pressure switch with N.O. contacts EB Series: Pressure switch with N.C. contacts With bypass 1.75 bar ER Series: Pressure switch with N.O. contacts EC Series: Pressure switch with N.C. contacts	Operational information: Max voltage: 48 Vac 50÷60 Hz Max current: 0.5 A resistive, 0.2 A inductive.	

Selection & installation information

Filter elements types

A Series

Absolute inorganic microfibre filtration media, available in 6, 10 and 25 micron
Example - **A06, A10** or **A25**

P Series

Nominal cellulose impregnated paper media, available in 10 and 25 micron.
Example - **P10** or **P25**

M Series

Metal mesh media, available in 25, 60, and 90 micron.
Example - **M25, M60** or **M90**.

Please refer to individual pressure drop curves to obtain filter assembly pressure drop information

The following filter sizing recommendations are based using a mineral oil fluid at 30 mm²/s (cSt) with a maximum total filter assembly (housing and filter element) pressure drop of 30% of the filter condition indicator (**0.4 bar** bypass type C)

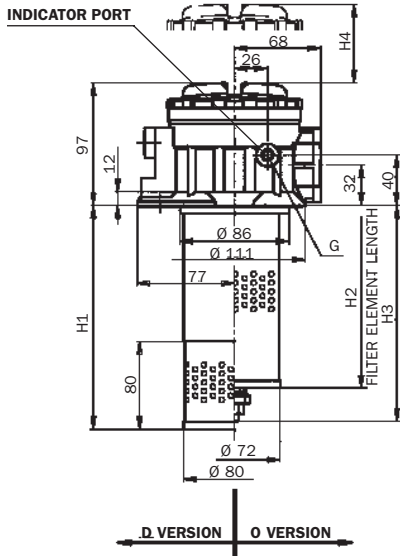

EQ - EB - ER - EC

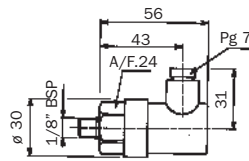

MPH 100

VR - VT

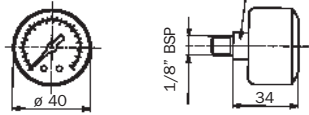

MPH SERIES 100 SIZE

Filter assembly	Flow rate l/min *	Bowl length	Port size BSP/NPT/SAE	Weight kg **
A06	27	1	3/4"	1,0
A10	38			
A25	110			
P10	100	2	3/4"	1,2
A06	40			
A10	60			
A25	150			
P10	120	3	1"	1,3
A06	65			
A10	75			
A25	200	4	1 1/4"	1,5
P10	180			
A06	75			
A10	110			
A25	270			
P10	260			

* Flow rates with 30 mm²/s fluid viscosity
** Weight including filter element and diffuser

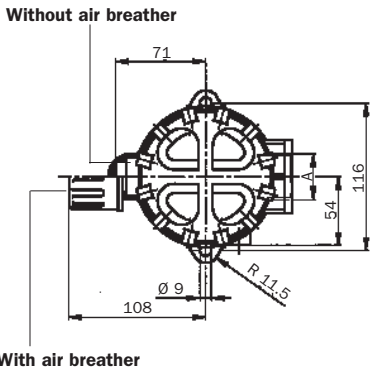

Holes on the tank

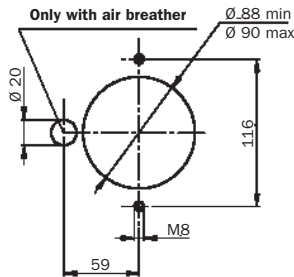

Lengths

Type	H1	H2	H3	H4
1	178	106	128	190
2	178	150	172	230
3	228	200	222	280
4	328	300	322	380

Housing pressure drop curves

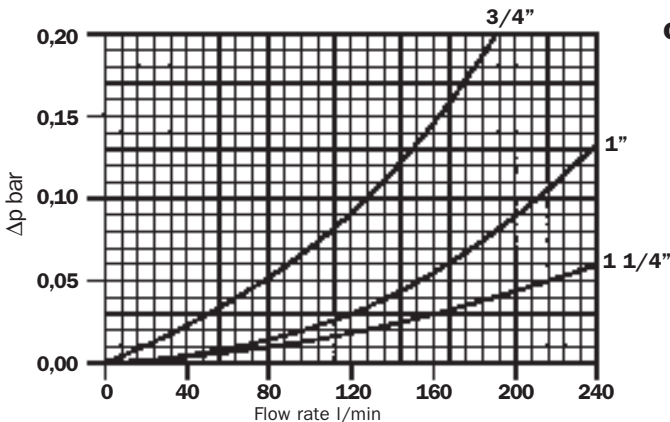

Thread connections

Type	A	G
G1	3/4" BSP	1/8" BSP
G2	1" BSP	1/8" BSP
G3	1 1/4" BSP	1/8" BSP
G4	3/4" NPT	1/8" NPT
G5	1" NPT	1/8" NPT
G6	1 1/4" NPT	1/8" NPT
G7	SAE 12 - 1 1/6" - 12 UN	1/8" NPT
G8	SAE 16 - 1 5/16" - 12 UN	1/8" NPT
G9	SAE 20 - 1 5/8" - 12 UN	1/8" NPT

Selection & installation information

Please refer to individual pressure drop curves to obtain filter assembly pressure drop information

The following filter sizing recommendations are based using a mineral oil fluid at 30 mm²/s (cSt) with a maximum total filter assembly (housing and filter element) pressure drop of 30% of the filter condition indicator (0.4 bar bypass type C)

MPH 250

MPH SERIES 250 SIZE

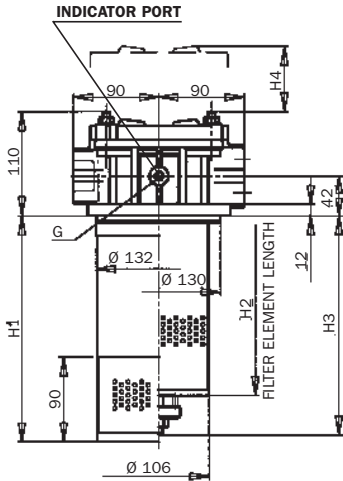

EQ - EB - ER - EC

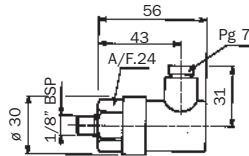

VR - VT

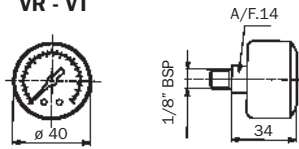

D VERSION | O VERSION

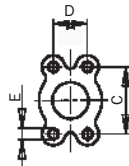
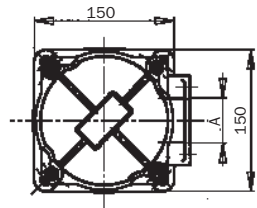
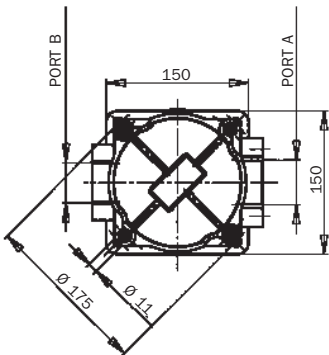

Holes on the tank

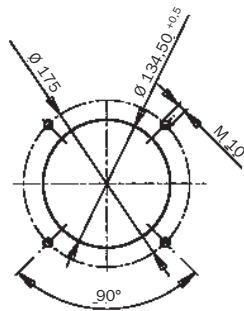

Housing pressure drop curve

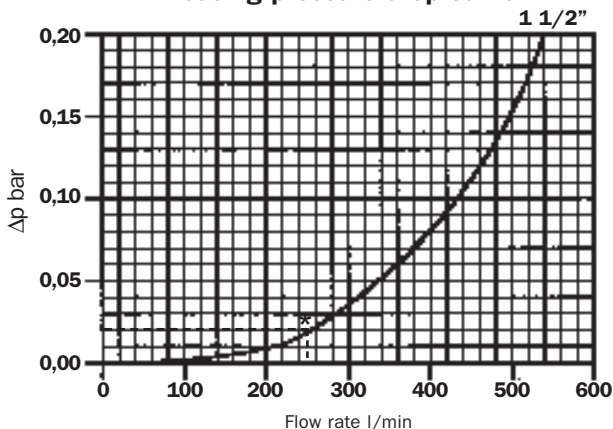

Filter assembly	Flow rate l/min *	Bowl length	Port size BSP/NPT/SAE	Weight kg **	
A06	110	1	1 1/2"	3,9	
A10	130			1 port	
A25	250			2 ports	
P10	230	2	1 1/2"	4,1	
A06	140			1 port	
A10	100			4,5	
A25	300	2 ports	3	1 1/2"	4,6
P10	330	1 port			
A06	200	1 port			
A10	250	4	1 1/2"	5,0	
A25	320			2 ports	
P10	400			2 ports	
A06	350	4	1 1/2"	4,8	
A10	440			1 port	
A25	500			5,2	
P10	500	2 ports			

* Flow rates with 30 mm²/s fluid viscosity
** Weight including filter element and diffuser

Lengths

Type	H1	H2	H3	H4
1	240	140	175	260
2	240	190	225	310
3	310	260	295	380
4	515	465	500	580

Thread connections

Type	Port A	Port B	G
G1	1 1/2" BSP	Not available	1/8" BSP
G2	1 1/2" BSP	1 1/4" BSP	1/8" BSP
G3	Not available	—	—
G4	1 1/2" NPT	Not available	1/8" NPT
G5	1 1/2" NPT	1 1/4" NPT	1/8" NPT
G6	Not available	—	—
G7	SAE 24 - 1 7/8" - 12 UN	Not available	1/8" NPT
G8	SAE 24 - 1 7/8" - 12 UN	SAE 20 - 1 5/8" - 12 UN	1/8" NPT

Flange connections (1 port)

Type	A	C	D	E
F1	1 1/2" SAE - 3000 PSI/M	69,95	35,71	M12
F3	1 1/2" SAE - 3000 PSI/UNC	69,85	35,71	1/2" UNC

Flange connections (2 ports)

Type	Port A/B	C	D	E
F2	A:1 1/2" SAE - 3000 PSI/M	69,85	35,71	M 12
	B:1 1/4" SAE - 3000 PSI/M			
F4	A:1 1/2" SAE - 3000 PSI/UNC	69,85	35,71	1/2" UNC
	B:1 1/4" SAE - 3000 PSI/UNC			

Selection & installation information

Please refer to individual pressure drop curves to obtain filter assembly pressure drop information

The following filter sizing recommendations are based using a mineral oil fluid at 30 mm²/s (cSt) with a maximum total filter assembly (housing and filter element) pressure drop of 30% of the filter condition indicator (**0.4 bar** bypass type C)

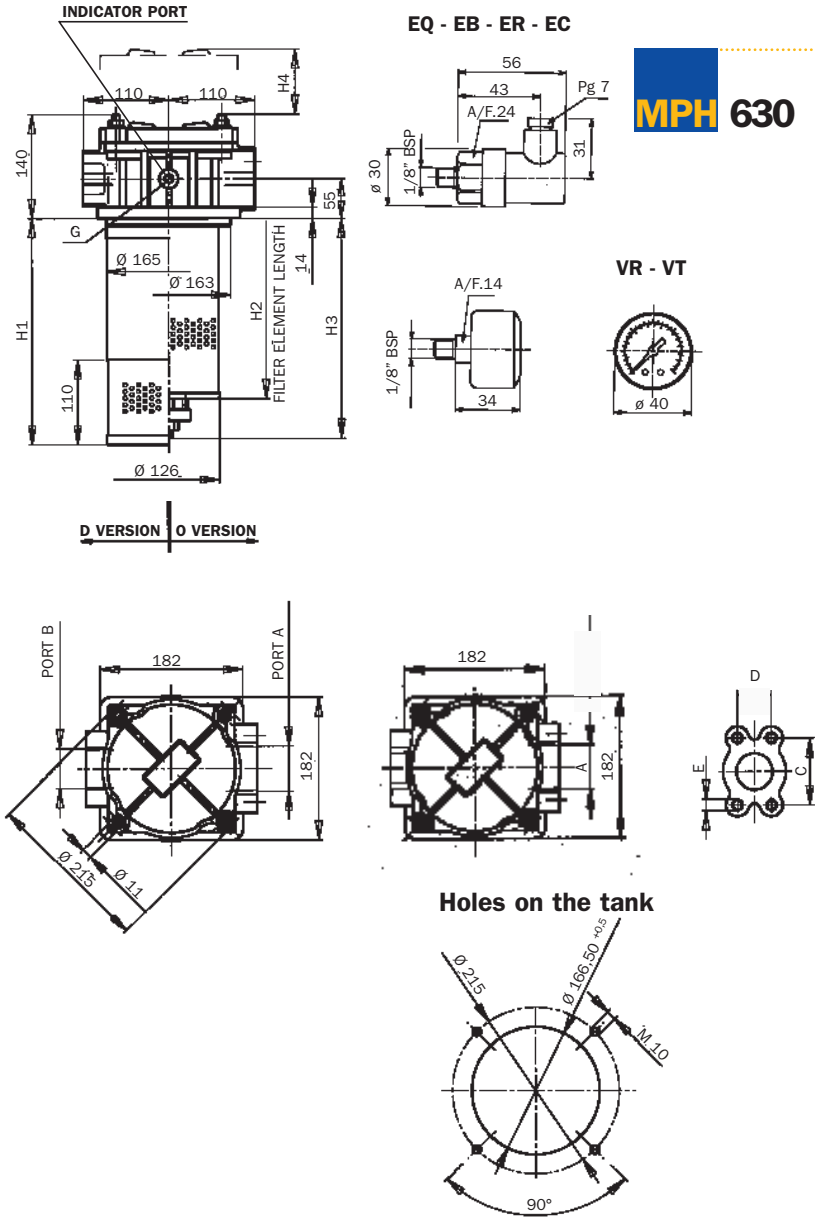

MPH SERIES 630 SIZE

Filter assembly	Flow rate l/min *	Bowl length	Port size BSP/NPT/SAE	Weight kg **
A06	200	1	2 1/2"	8,2
A10	300			
A25	440			
P10	420	2	2 1/2"	8,7
A06	290			
A10	400			
A25	700	3	2 1/2"	9,0
P10	580			
A06	320			
A10	480	4	2 1/2"	9,5
A25	960			
P10	800			
A06	360	4	2 1/2"	9,5
A10	520			
A25	1050			
P10	900			

* Flow rates with 30 mm²/s fluid viscosity
 ** Weight including filter element and diffuser

Lengths

Type	H1	H2	H3	H4
1	280	210	260	350
2	360	290	340	430
3	460	390	440	530
4	550	478	530	620

Housing pressure drop curve

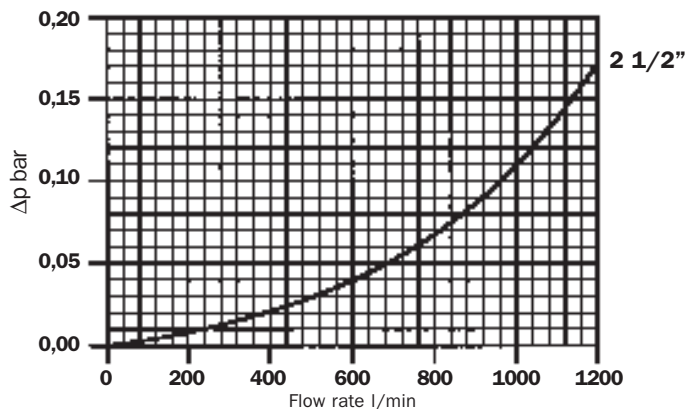

Flange connections (1 port)

Type	A	C	D	E	G
F1	2 1/2" SAE - 3000 PSI/M	88,90	50,80	M 12	1/8" BSP
F3	2 1/2" SAE - 3000 PSI/UNC	88,90	50,80	1/2" UNC	1/8" NPT

Flange connections (2 ports)

Type	Port A/B	C	D	E	G
F2	A: 2 1/2" SAE - 3000 PSI/M B: 2" SAE - 3000 PSI/M	88,90 77,80	50,80 42,90	M 12 M 12	1/8" BSP
F4	A: 2 1/2" SAE - 3000 PSI/UNC B: 2" SAE - 3000 PSI/UNC	88,90 77,80	50,80 42,90	1/2" UNC 1/2" UNC	1/8" NPT

Selection & installation information

Please refer to individual pressure drop curves to obtain filter assembly pressure drop information

The following filter sizing recommendations are based using a mineral oil fluid at 30 mm²/s (cSt) with a maximum total filter assembly (housing and filter element) pressure drop of 30% of the filter condition indicator (**0.4 bar** bypass type C)

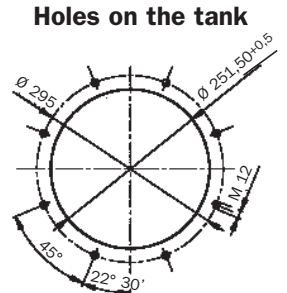
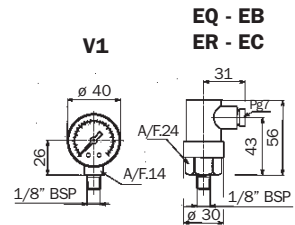
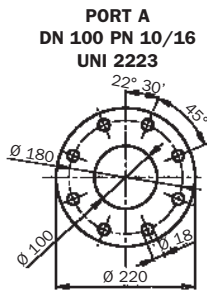
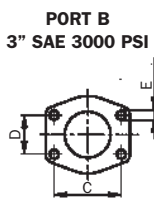
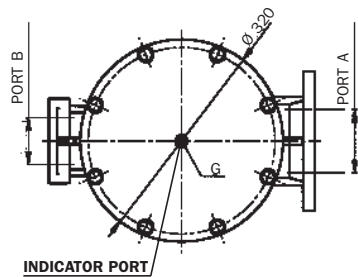
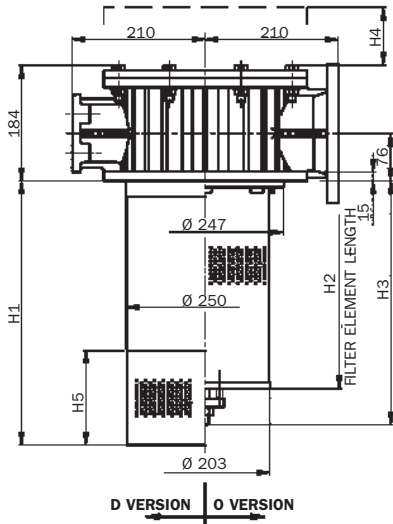

MPH SERIES 850 SIZE

MPH 850

Filter assembly	Flow rate l/min *	Bowl length	Port size BSP/NPT/SAE	Weight kg **
A06	550	1	4"	30,0
A10	800			
A25	1350			
P10	1150	2	4"	34,0
A06	900			
A10	1320			
A25	1800	3	4"	37,0
P10	1400			
A06	900			
A10	1400			
A25	2100			
P10	2000			
A06	1100			
A10	1500			
A25	2400			
P10	2300			

* Flow rates with 30 mm²/s fluid viscosity
** Weight including filter element and diffuser

Lengths

Type	H1	H2	H3	H4	H5
1	420	330	388	520	150
2	635	545	603	740	150
3	915	825	883	1020	250
4	1180	1090	1148	1290	250

Housing pressure drop curve

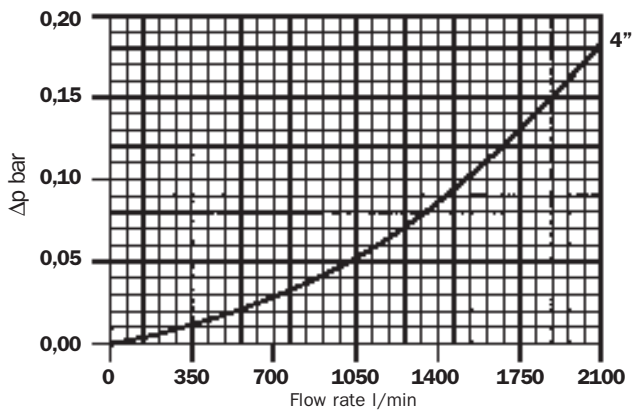

Flange connections

Type	Port A/B	C	D	E	G
F1	A: DN 100 PN 10/16 B: 3" SAE - 3000 PSI/M	106,38	61,93	M 16	1/8" BSP
F3	A: DN 100 PN 10/16 B: 3" SAE - 3000 PSI/UNC	106,38	61,93	5/8" UNC	1/8" NPT

General

Pressure drop versus flow rate curve information for both housing and filter elements is in accordance with ISO 3968

Filter assembly pressure drop - $\Delta p_{\text{Total}} = \Delta p_{\text{Housing}} + \Delta p_{\text{Filter element}}$

Housing pressure drop - The housing pressure drop is proportional to the fluid density

Filter element pressure drop - Filter element pressure drop is proportional to kinematic viscosity therefore always check the fluid operating temperature and fluid type to obtain the working viscosity according to the following formula:

$$\Delta p_1 \text{ Filter element} = (\text{working viscosity} / \text{brochure viscosity}) \times \Delta p \text{ filter element}$$

Brochure viscosity 30 mm²/s (cSt)

Filter assembly sizing example

- Customer requires a 250 l/min filter assembly (with bypass valve setting at 1.75 bar type C)
- Mineral oil fluid: ISO VG 46 (46 mm²/s (cSt) at 40°C)
- A25 - 25 micron absolute filtration

Selection :

- **Housing pressure drop** - MPH 250-3 with 250 l/min $\Delta p = 0.02$ bar (see curve on page 6)
- **Filter element pressure drop** (brochure viscosity) - MR 250-3 A25 with 250 l/min $\Delta p = 0.22$ bar (see curve on page 10)
- **Filter element pressure drop** (working viscosity) - With 46 mm²/s (cSt) $\Delta p_1 = 0.22 \times (46/30) = 0.33$ bar
- **Filter assembly pressure drop** $\Delta p_{\text{Total}} = \Delta p_{\text{Housing}} + \Delta p_1 \text{ Filter element} = 0.02 + 0.33 = \mathbf{0.35 \text{ bar}^*}$ { Acceptable pressure drop value, as per our recommendations

Bypass valves pressure drop

The curves were obtained using a mineral oil with a density of 0,86 kg/dm³. The Δp varies proportionally to the density.

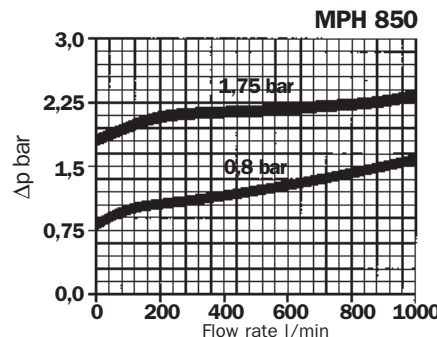
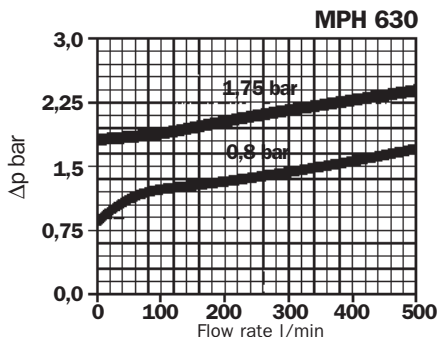
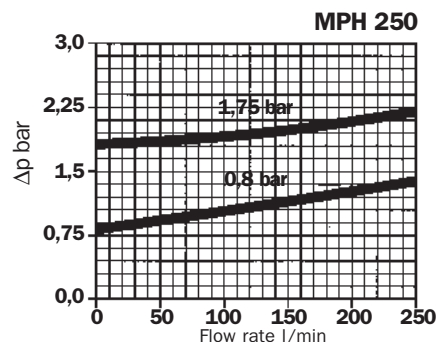
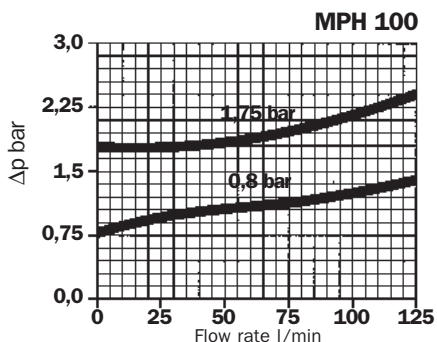

Filter elements - A Series -

The curves were obtained using a mineral oil with a kinematic viscosity of 30 mm²/s (cSt).
The Δp varies proportionally to the fluid kinematic viscosity.

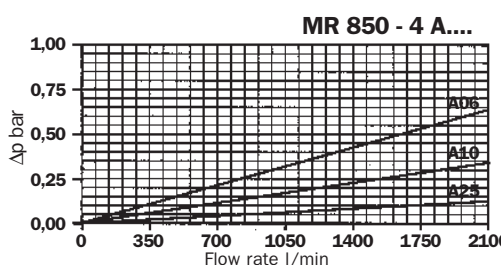
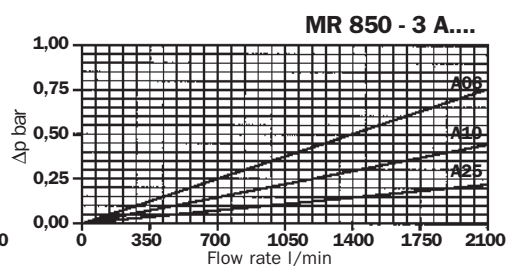
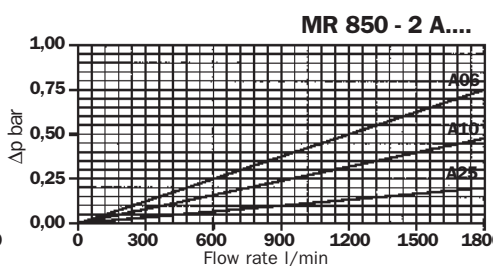
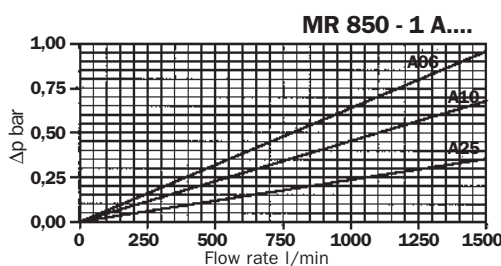
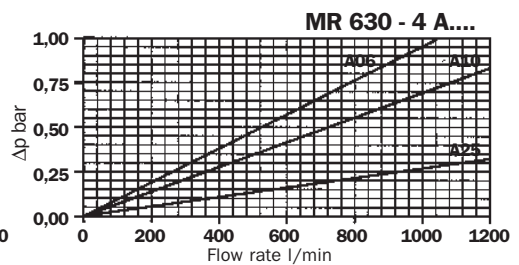
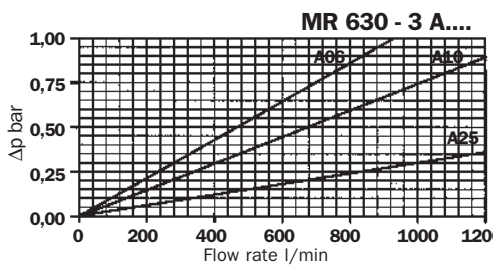
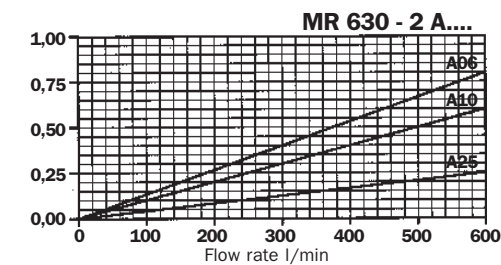
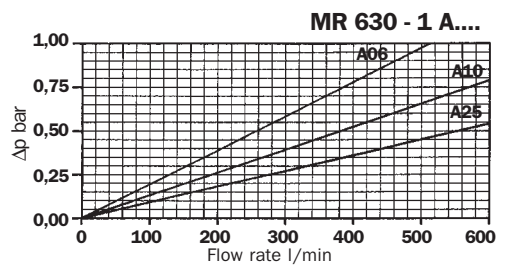
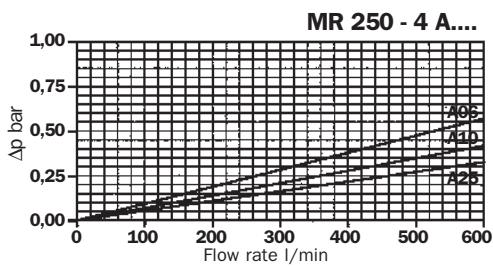
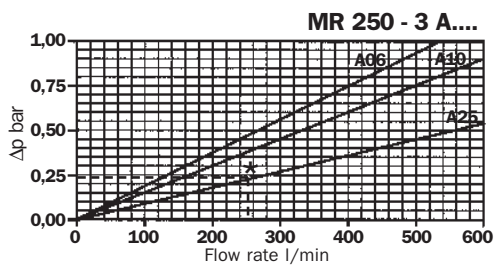
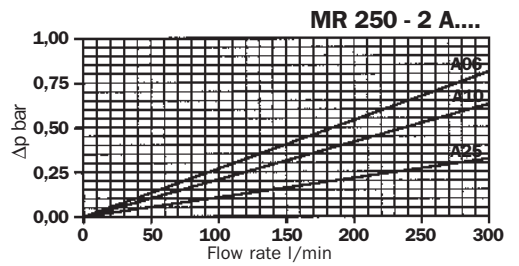
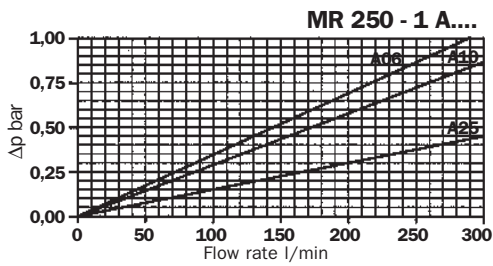
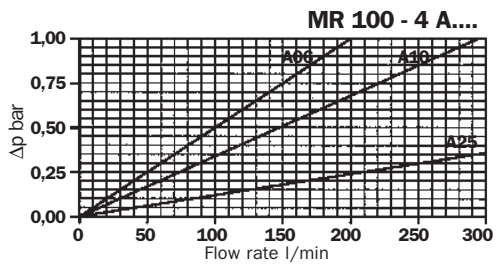
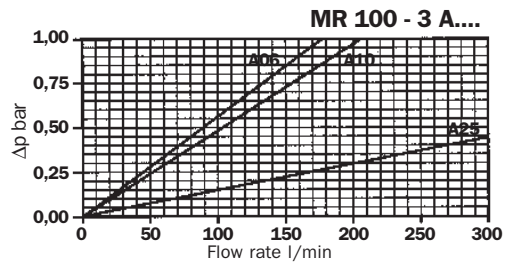
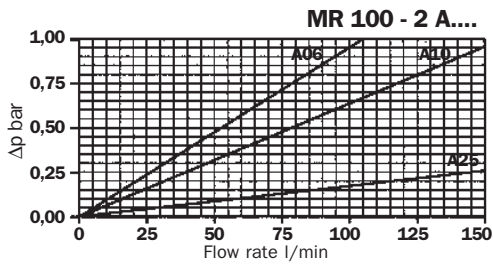
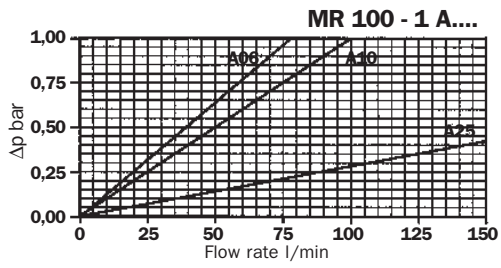

* Example: See page 9

Filter elements - P Series -

The curves were obtained using a mineral oil with a kinematic viscosity of 30 mm²/s (cSt).
The Δp varies proportionally to the fluid kinematic viscosity.

For the metal mesh filter elements curves (M series), please consult our Sales Network Organization

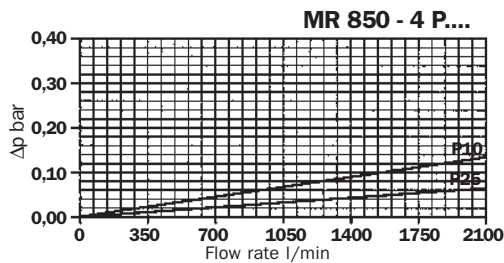
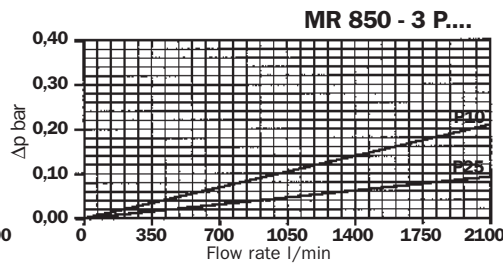
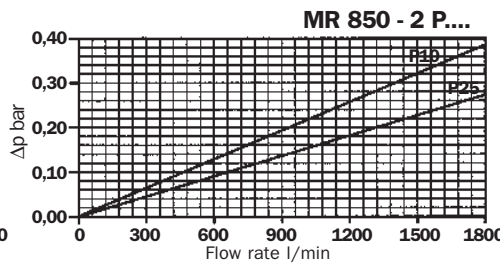
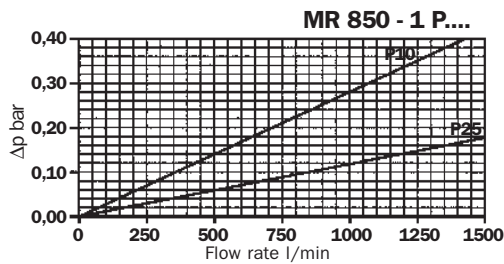
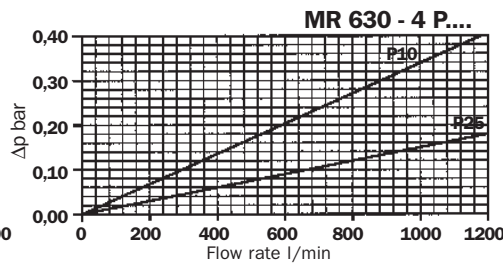
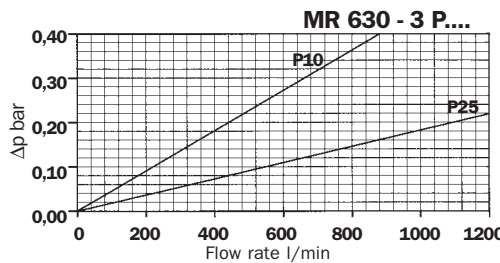
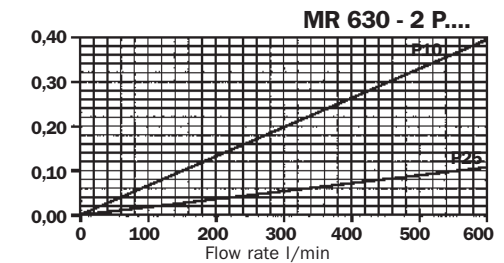
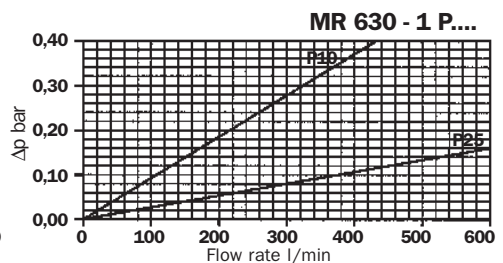
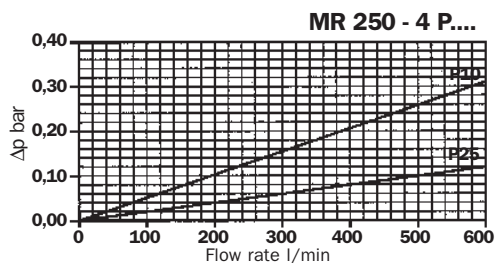
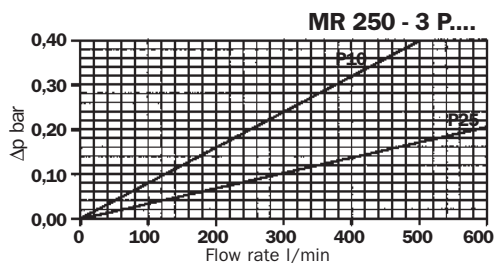
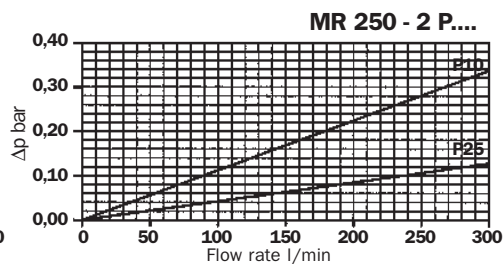
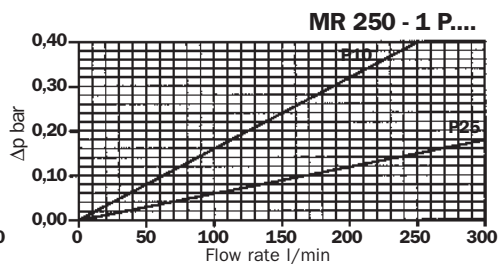
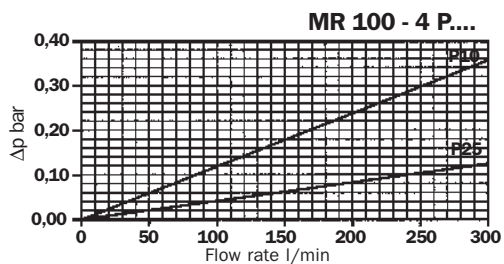
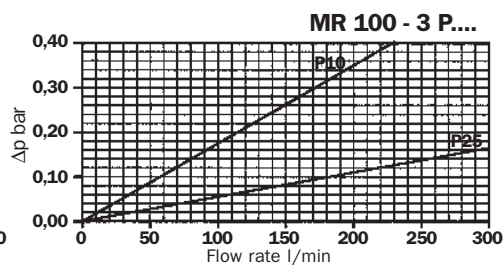
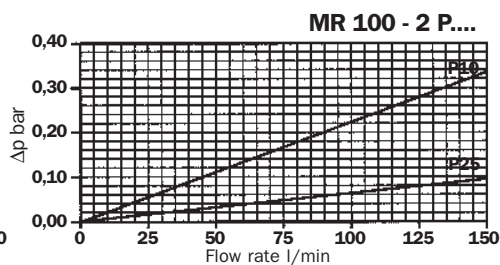
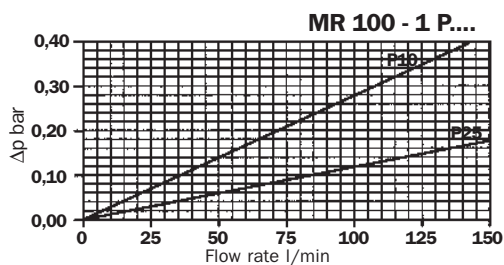

MPI Filters

IN TANK FILTRATION UNIT - INCLUDES ELEMENT, DIFFUSER AND BYPASS VALVE ASSY

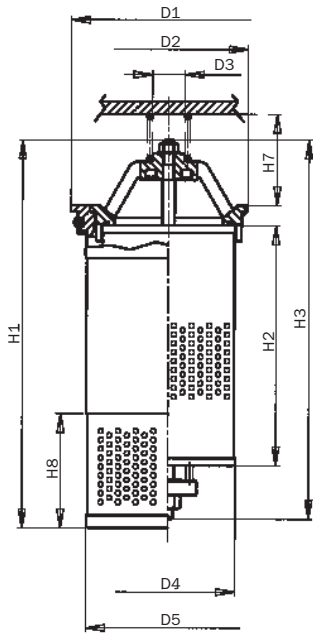

Tank internal plate without diffuser

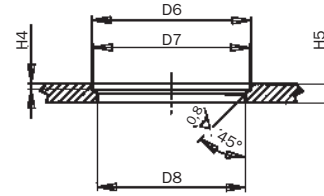

Tank internal plate with diffuser

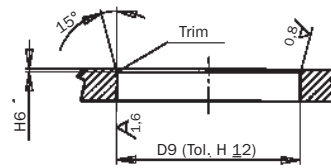

Type	H1	H2	H3	H4	H5	H6	H7	H8	D1	D2	D3	D4	D5	D6	D7	D8	D9
100-1	245	106	180	4	12	2,5	45	80	120	87	20	72	89	88	82,5	76	110
100-2	245	150	224														
100-3	295	200	274														
100-4	395	300	374														
250-1	307	140	250	5	15	2,5	78	90	155	125,5	25	106	133	126	123,5	117	145
250-2	307	190	300														
250-3	377	260	370														
250-4	582	465	577														
630-1	355	210	341	5	18	2,5	100	110	185	150	25	126	165	151	149	139	178
630-2	445	290	421														
630-3	545	390	521														
630-4	635	478	609														
850-1	530,5	330	515	6	20	2,5	140	250	260	230	40	203	245	231	227	217	250,5
850-2	745,5	545	730														
850-3	1025,5	825	1010														
850-4	1290,5	1090	1275														

Applications

Example of application

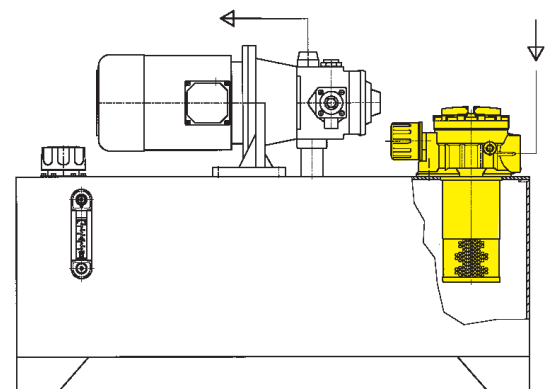



A series of horizontal dashed lines for writing, alternating between blue and yellow colors. The lines are spaced evenly down the page, providing a guide for handwriting practice.



MPI

Nominal sizes

100
250
630
850

Filter elements

A06	Inorganic microfibre Bx ≥ 200
A10	
A25	
P10	Resin-impregnated paper Bx ≥ 2
P25	
M25	Square wire mesh
M60	
M90	

Lengths

MPH 100 = 1,2,3,4
MPH 250 = 1,2,3,4
MPH 630 = 1,2,3,4
MPH 850 = 1,2,3,4

Seals

A	Nitrile (Buna-N)
V	Viton

Integral bypass valve

B	Setting: 0.8 bar
C	Setting: 1.75 bar

Models

O	Without diffuser
D	With diffuser

MR

Ordering information

MPH

Nominal sizes

100
250
630
850

Lengths

MPH 100 = 1,2,3,4
MPH 250 = 1,2,3,4
MPH 630 = 1,2,3,4
MPH 850 = 1,2,3,4

Integral bypass valve

B Setting: 0.8 bar
C Setting: 1.75 bar

Models

O Without diffuser
D With diffuser

Air breather

S Without air breather
C With 10 µm air breather (100 series only)
M With 40 µm air breather (100 series only)

Seals

A Nitrile (Buna-N)
V Viton

Filter condition indicator

S With threaded hole only
T With plug
VT Visual (setting at 0.6 bar)
VR Visual (setting at 1.3 bar)
V1 Visual MPH 850 only (setting at 1.3 bar)
EQ Electrical: N.O.contacts (setting at 0.6 bar)
EB Electrical: N.C.contacts (setting at 0.6 bar)
ER Electrical: N.O.contacts (setting at 1.3 bar)
EC Electrical: N.C.contacts (setting at 1.3 bar)

Filter elements

A06
A10
A25 Inorganic microfibre Bx ≥ 200
P10
P25 Resin-impregnated paper Bx ≥ 2
M25
M60
M90 Square wire mesh

Ports option

Type	100	250	630	850
G1	3/4" BSP	1 1/2" BSP	=====	=====
G2	1" BSP	1 1/2" BSP 1 1/4" BSP	=====	=====
G3	1 1/4" BSP	=====	=====	=====
G4	3/4" NPT	1 1/2" NPT	=====	=====
G5	1" NPT	1 1/2" NPT 1 1/4" NPT	=====	=====
G6	1 1/4" NPT	=====	=====	=====
G7	SAE 12	SAE 24	=====	=====
G8	SAE 16	SAE 24 SAE 20	=====	=====
G9	SAE 20	=====	=====	=====
F1 (M)	=====	1 1/2" SAE	2 1/2" SAE	DN 100 PN 10/16 3" SAE
F2 (M)	=====	1 1/2" SAE 1 1/4" SAE	2 1/2" SAE 2" SAE	=====
F3 (UNC)	=====	1 1/2" SAE	2 1/2" SAE	DN 100 PN 10/16 3" SAE
F4 (UNC)	=====	1 1/2" SAE 1 1/4" SAE	2 1/2" SAE 2" SAE	=====

MPH 250, G2-G5-G8 options have double port connection.
MPH 250-630, F2-F4 options have double port connection.
MPH 850 options, only available with double port connection.

MR

Replacement element

MP Filtri - Filtration products will only be guaranteed if original MP Filtri replacement elements and spares are used

Data held in this publication is given only for indicative purposes. MP Filtri reserves to introduce modifications to described items for technical or commercial reasons. Copyright reserved.



Head Quarter :

MP FILTRI S.p.A. Italy

Via Matteotti, 2
20060 Pessano con Bornago (Milano) Italy
Tel. ++39.02/95703.1
Fax ++39.02/95741497-95740188
email: sales@mpfiltri.com
<http://www.mpfiltri.com>

GREAT BRITAIN

MP FILTRI U.K. Ltd.

Bourton Industrial Park
Bourton on the Water
Gloucestershire GL54 2HQ UK
Phone: 01451-822522
Fax: 01451-822282
email: sales@mpfiltri.co.uk
<http://www.mpfiltri.co.uk>



GERMANY

MP FILTRI D GmbH

Am Wasserturm 5
D-66265 Heusweiler/Holz
Phone: 06806/85022-0
Fax: 06806/85022-18
email: mpfiltrink@aol.com

FRANCE

MP FILTRI FRANCE

B.P. 325
01603 Trevoux Cedex
Tel: 04.74.08.84.78
Telefax: 04.74.08.80.45
email: mpfiltrifrance@wanadoo.fr

USA

MP FILTRI USA Inc.

2055 Quaker Pointe Drive
Quakertown, PA 18951
Phone: 215-529-1300
Fax: 215-529-1902
email: mpusasales@aol.com
<http://www.mpfiltriusa.com>

CANADA

MP FILTRI CANADA Inc.

210 Jacob Keffer Parkway Concord,
Ontario Canada L4K 4W3
Phone: 905-303-1369
Fax: 905-303-7256
email: mail@mpfiltricanada.com
<http://www.mpfiltricanada.com>